



Dependable Products From People You Trust



Dynamic Linear Swell Meter with Compactor

#150-80 - 115V

#150-80-1 - 230V

Software Version 3.09.0

Instruction Manual

Updated 1/26/2023

Ver. 9

OFI Testing Equipment, Inc.

11302 Steeplecrest Dr. · Houston, Texas · 77065 · U.S.A.

Tele: 832.320.7300 · Fax: 713.880.9886 · www.ofite.com

©Copyright OFITE 2015

Table of Contents

Intro	2
Safety	2
Components	3
Installation	4
Software	6
<i>Zeroing the Channels</i>	8
<i>Calibration</i>	9
<i>Starting a Test</i>	10
<i>Setup</i>	12
<i>Analog Input</i>	13
Operation	14
Sample Data	15
<i>Graph 1</i>	16
<i>Graph 2</i>	17
<i>Graph 3</i>	18
<i>Graph 4</i>	19
Compactor	20
<i>Assembly</i>	20
<i>Making Wafers</i>	22
<i>Disassembly</i>	23
Drawings	24
<i>Cup Assembly</i>	24
<i>Head Assembly</i>	25
<i>Main Assembly</i>	26
<i>Wafer Die</i>	27
Warranty and Return Policy	28

Intro

The OFITE Dynamic Linear Swell Meter is a highly effective method of examining the interaction between water based fluids and mineral samples containing reactive clays under simulated conditions while fluid is in motion. The observed swelling characteristics are utilized to anticipate and/or correct the oftentimes unpredictable problems that are frequently encountered while drilling in shale formations. It is a very useful tool when designing drilling fluids or when testing the behavior of existing muds because it shows the changes in the clay/fluid interaction for short periods of time (0 - 5 minutes) as well as longer periods (>350 minutes). Bit balling, pipe drag, hole sloughing and other "Gumbo" related shale problems may be predicted in advance, enabling the operator to select the proper drilling fluid and therefore achieve a stable wellbore environment.

The OFITE multiple channel Dynamic Linear Swell Meter features multiple measuring heads for simultaneously testing up to eight (8) cores or drilling fluids. A mineral (shale, core sample, cuttings, crude bentonite, etc.) wafer is exposed to a drilling fluid which is circulated around the wafer. A Linear Variable Differential Transducer (LVDT) measures the expansion of the wafer in the vertical direction (accuracy to 0.1%) and this information is then stored as a function of time via the data acquisition system. A hydraulic compactor unit prepares the mineral wafers for placement inside the transfer stand and subsequent testing.

Safety



1. All electrical power cables should be three wire grounding cables and should be plugged only into a grounded receptacle. The power switch on the instrument should be in the OFF position when connecting the power cable.
2. Always unplug the instrument from the electrical power source before performing any disassembly or repair. With the cover off, it is possible to touch exposed electrical terminals resulting in electrical shock if the power cable is plugged in.
3. Ensure that all pressure has been released on the compactor before removing core chambers. Both pressure gauges should read zero before any work or maintenance is performed on the compactor.
4. Clean up any spilled hydraulic oil to prevent injury or fire hazards.
5. The maximum temperature of the hot plate is 212°F (100°C), which is the boiling point of water. Because the sample cup is not pressurized, we recommend a maximum test temperature of 200°F (93.3°C). Testing at the boiling point could result in the fluid boiling out of the cup and splattering people and equipment. If this happens, immediately decrease the temperature to a safe level.

Components

Computer:

- #130-75-71 Monitor
- #500-300-015 Micro Computer

Swell Meter:

- #130-76-03 Thermocouple
- #150-80-101 Calibration Block, Multi Point
- #150-80-03 Flat Screen; 1 1/16" Diameter
- #150-80-031 Teflon Washer
- #150-80-032 Transfer Stand
- #150-80-033 Wafer Tube
- #150-80-034 Bottom Plate
- #150-80-035 Cup
- #150-80-036 Cap for Wafer Tube
- #150-80-064 LVDT
- #150-80-094 Cable, LVDT to Swell Meter
- #150-83 Stirring Hot Plate; 120 Volt Only
- #150-84 Stirring Hot Plate; 230 Volt Only
- #152-37 AC Power Cord; 3-Conductor
- #153-53-1 Magnetic Stir Bar, 1"
- #153-67 60 cc Disposable Syringe

Compactor (#150-82):

- #150-80-072 Pump
- #150-80-085 1/2" Spacer
- #150-80-086 3/4" Spacer
- #150-80-087 Body for Wafer Mold
- #150-80-088 Plunger for Wafer Mold
- #150-80-089 Drop Tube for Wafer Mold
- #150-85 Relief Valve; 2,900 PSI (20 MPa)

Optional:

- #150-80-009 Brass Weight
- #150-81-1 Swell Meter Control Assembly (115 V)
- #150-81-2 Swell Meter Control Assembly (230 V)

Installation

1. Assemble the Cup Assemblies as illustrated below and in the drawing on page 24. The brass weight is an optional piece for simulating an overburden pressure applied to the swelling core sample.

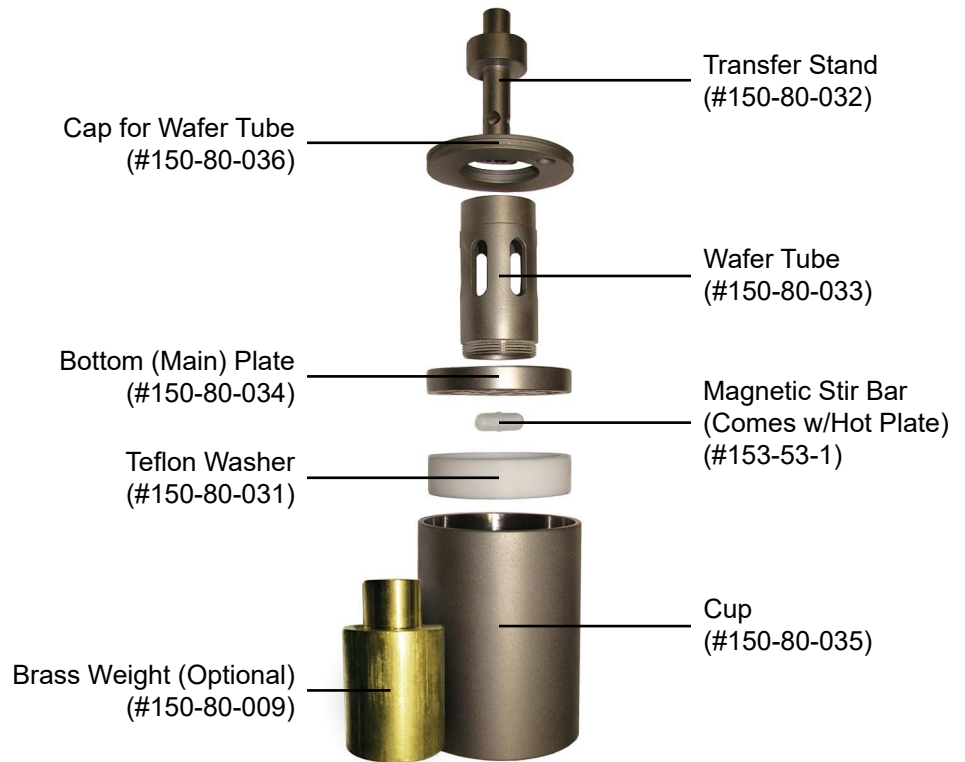

2. Assemble the Main Assemblies as depicted below and in the drawing on page 26. Adjust the height of the head assembly such that there is a small gap (approximately 5 mm) between the bottom of the nut on the spindle and the body of the LVDT without a wafer inserted into the cup assembly.

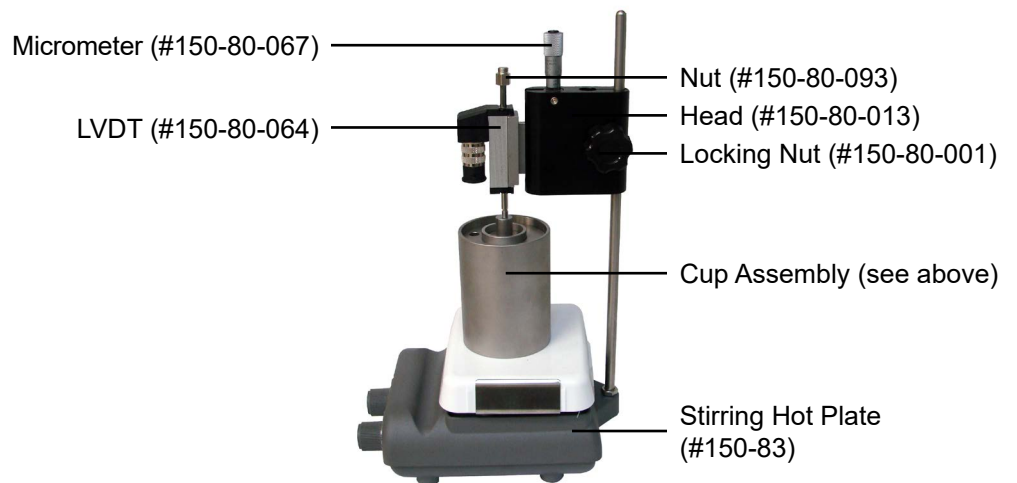



Tip

3. Connect the transducer cables to the LVDTs and then plug them into the Swell Meter box.
4. Plug the magnetic stirrers into the electrical receptacles located on the back of the unit.

These cables can be run under the Swell Meter box for a neater appearance.

5. Insert the thermocouples into the cup assemblies and plug them into the front of the Swell Meter box.
6. Ensure that the “POWER” switches (located on the back of the Swell Meter) are in the “OFF” position and make the necessary electrical connections in accordance to local codes. Ensure that the unit is grounded.
7. Make sure the computer is securely mounted to the back of the monitor.
8. Connect all the necessary cables to the appropriate ports.

The computer connects to the Swell Meter via the supplied USB cable. Make sure the Bluetooth receiver is plugged in so that the keyboard and mouse can connect.

If the computer runs out of disk space, it will no longer be able to store more test data. If this happens, move older test data to a network or flash drive to free up additional space.



Bluetooth Receiver

USB Cable (To Swell Meter)

Software

Turn the PC on and start the software by clicking the Swell Meter icon on the desktop. The first time you start the software, you will be asked to select a hardware configuration. If your Swell Meter was manufactured before June 2018, choose “Swell Meter”. If it was manufactured in June 2018 or later, choose “Swell Meter V2”. If you are not sure, look at the cable connecting the computer to the Swell Meter. If it is a flat, wide ribbon cable, select “Swell Meter”. If it is a standard USB cable, select “Swell Meter V2”.

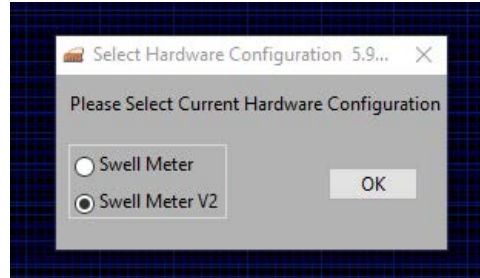

The Main Screen will appear:

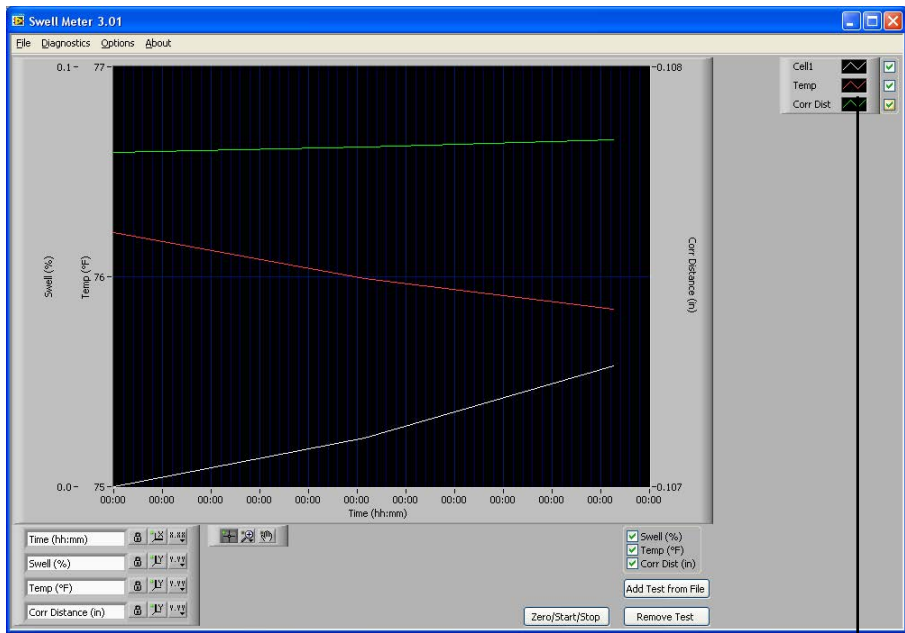

Legend

The checkboxes at the bottom, right-hand corner of the graph control which information (for all cells) is available to display on the graph. Once a test is started, you can show or hide the swell percentage, temperature, or corrected distance for all cells. For example, unchecking the “Temp” checkbox will remove all temperature lines from the graph.

The legend on the right-hand side of the screen controls which information (for each individual cell) displays on the graph. Once a test is started, you can show or hide the swell percentage, temperature, or corrected distance for a give cell. For example, unchecking the “Temp” checkbox under “Cell1” will remove only the temperature line for Cell1 from the graph. By right-clicking on the checkboxes, you can view test details for the cell you clicked, export test data, remove a test from the chart, or print a chart. If you choose “Print”, the chart will print all the data point currently being displayed.



Tip

At times the graph may appear unexpectedly erratic, especially at the beginning of a test. This is likely caused by the scale on the Y-axis being set too low. To correct the issue, right-click on the Y-axis and deselect “AutoScale Y”. Then click the top value on the Y-axis and change it to a higher number. It may take some experimentation to get the right scale.



Note

By default, the software is configured to run four cells at a time. If your Swell Meter has been configured to run eight cells instead of just four, you will need to change the “Number of Cells Available” option on the “Setup” screen to 8. This will enable to software to run all eight cells. Refer to page 12 for instructions.

Export: There are two export procedures in the software. You can export a test that is currently in process, or you can export a completed and saved test. Both procedures create a file that can then be opened in Microsoft Excel.

To export a test that is running, right-click the checkboxes on the legend and select “Export” to save your test data to a file. This procedure exports whatever data points are currently displayed on the graph.

To export a saved test, click “Export from File” on the “File” menu. Choose the file corresponding to the test you want to export. Then choose a destination for the exported file. This procedure will import the saved test data and then export it into an Excel spreadsheet.

Zero/Start/Stop: Click this button to start or stop a test.

Add Test From File: Click this button to add data from a saved test to the graph. This is useful for comparing the results of multiple tests on one graph.

After adding a test to the graph, use the checkboxes below the graph and on the legend to display the information you need to see.

Remove Test: Click this button to remove a test from the graph.

Software

Zeroing the Channels

Each channel must be zeroed before every test. This gives the software a starting point with which to calculate the percentage of swell during the test.

1. Click the “Zero/Start/Stop” button.

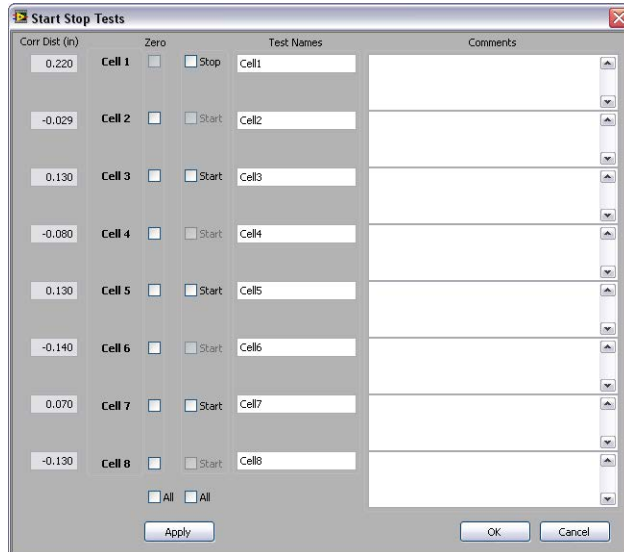

2. Repeat the following steps for each channel to be tested:
 - a. Enter a test name and any comments.
 - b. Place two screens into a fully-assembled cup. Place the cup on the magnetic stirrer so that the LVDT spindle is resting on top of the transfer stand. Check the box in the “Zero” column next to each cell to be tested.
 - c. Click the “Apply” button to zero the channel. Make sure the “Corr Dist (in)” field reads 0.000.

Software

Calibration

To determine if a cell needs to be calibrated, zero the transducer (see page 8) and then place the calibration block underneath the LVDT rod. If the corrected distance does not correspond to the marking on the calibration block, the cell should be calibrated.

1. Place an empty sample cup upside down on the stirring hot plate. Make sure the rod of the LVDT is resting on the bottom of the cup.
2. In the Swell Meter software, select “Calibration” from the “Options” menu.
3. Choose the cell you want to calibrate and click the “Calibrate Cell” button.

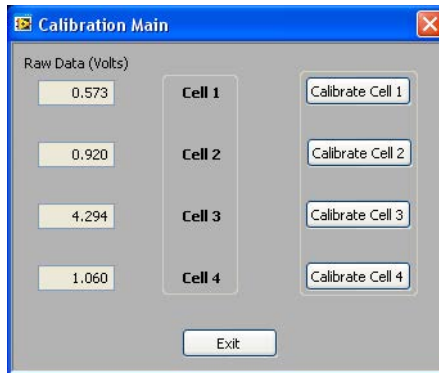

Calibration Block (#150-80-101)

4. Adjust the LVDT head up and down on the stand until the voltage reads 0. Tighten the locking nut and use the micrometer for fine adjustments.
5. Place the calibration block (#150-80-101) on the surface of the cup and rest the LVDT rod on the portion of the block that reads .20. Be sure to let the reading stabilize before continuing.
6. Click “Accept”.
7. Repeat steps 5 and 6 with each level on the calibration block.
8. After measuring all five levels, click the “Save” button to finish.

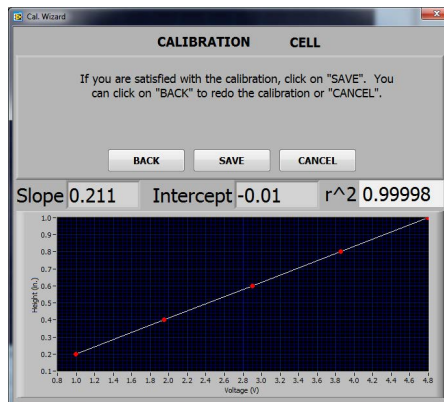

Software

Starting a Test

Perform the following steps for each channel to be tested:

1. Zero the channel. Refer to page 8 for instructions.
2. Remove the transfer stand from the cup.

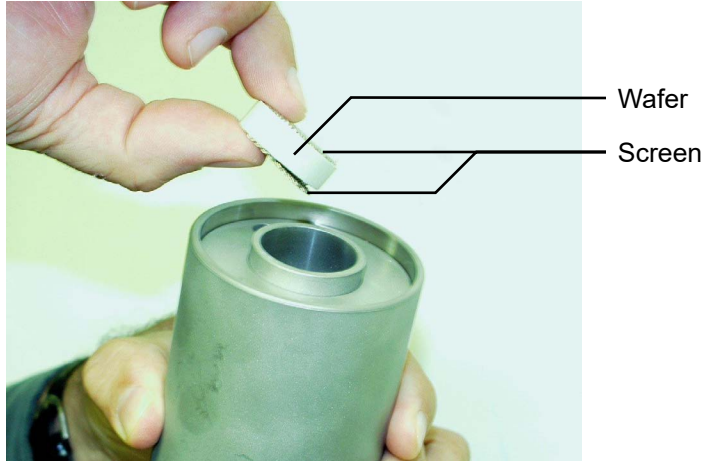

3. Place a screen on both sides of the compacted wafer and insert it into the wafer tube with the transfer stand on top of it.
4. Place the LVDT spindle on top of the transfer stand.
5. Click the “Zero/Start/Stop” button.
6. Check the “Start” box next to each cell to be tested. To stop a test that is currently running, check the “Stop” box.
7. Click the “Apply” button to start testing in the selected channels.
8. Immediately add the test fluid to the cup through the hole in the cap.

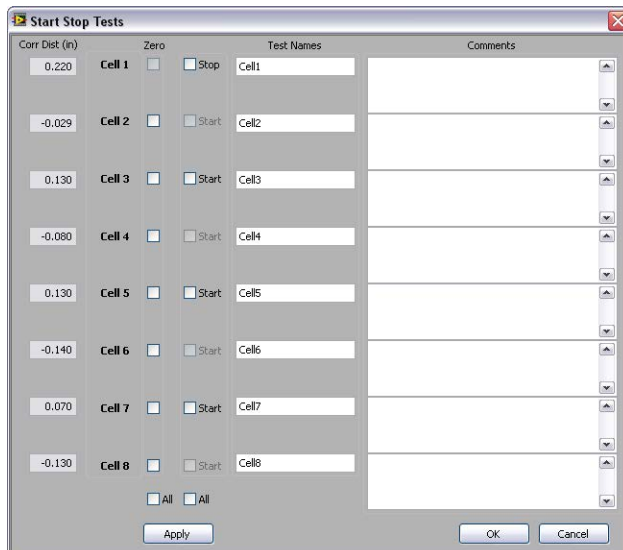

- Click "OK" to return to the main screen. The software will now begin graphing the data from the test.

To see the raw data at any time during a test, select "Cell Data" from the "Diagnostics" menu. This screen will only show data for the number of cells specified on the "Options" screen.



Temp: This shows the current temperature of the sample. (°F / °C)

Raw Dist: This is the raw distance shown by the transducer. (inches / mm)

Cell Tare: This is the raw distance that was recorded when the channel was zeroed. This value is subtracted from the current raw distance reading to calculate the corrected distance. (inches / mm)

Init Samp: This is the initial distance of the sample. This value is the raw distance when the test is started. (inches / mm)

Corr Dist: This is the corrected distance. It is equal to the raw distance minus the cell tare. (inches / mm)

Swell: This is the percentage the sample has swelled since the test began. (%)

Start Time: This is the time the test was started.

Elapsed Time: This is the time elapsed since the test was started.

Test Active: This light shows if data is being recorded for this cell. (on/off)

Hold Data: This light shows if the data from a stopped test is still being held in memory. (on/off)

Software

Setup

Select "Setup" from the "Options" menu.

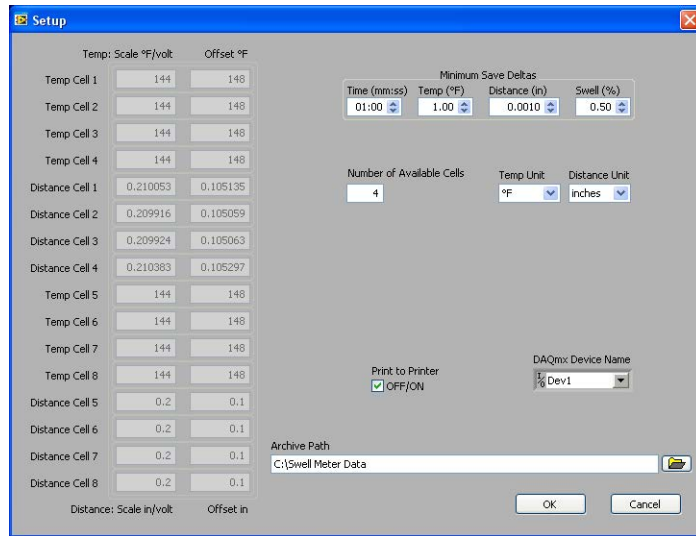

Minimum Save Deltas: These fields determine how often data is saved to the file. A data point will be recorded when any of the values changes by the amount specified.

Time: To set the save period to one minute, set the value in this field to "01:00".

Temp: If the value in this field is set to 1, a data point will be recorded whenever the temperature changes by more than 1°. Units are determined by the "Temp Unit" field below.

Distance: If the value in this field is set to "0.0010", a data point will be recorded whenever the corrected distance changes by more than 0.001. Units are determined by the "Distance Unit" field below.

Swell: To record a data point whenever the swell % change by .01%, set the value in this field to .01.

Number of Available Cells: By default, the Swell Meter can operate four cells at a time. If your Swell Meter has an extra control card installed (optional), change this value to eight.

Temp Unit / Distance Unit: Choose the temperature unit (°F or °C) and distance unit (in or mm) you wish to use.

Archive Path: Select a folder to store test data.

Print to Printer: When a test prints, the software automatically creates an image file of the chart. If the Print to Printer open is selected, it will also print to the default printer.

Software

Analog Input

The Analog Input screen is used for troubleshooting and diagnostic purposes only. If you experience communication problems, select “Analog Input” from the “Diagnostics” menu.

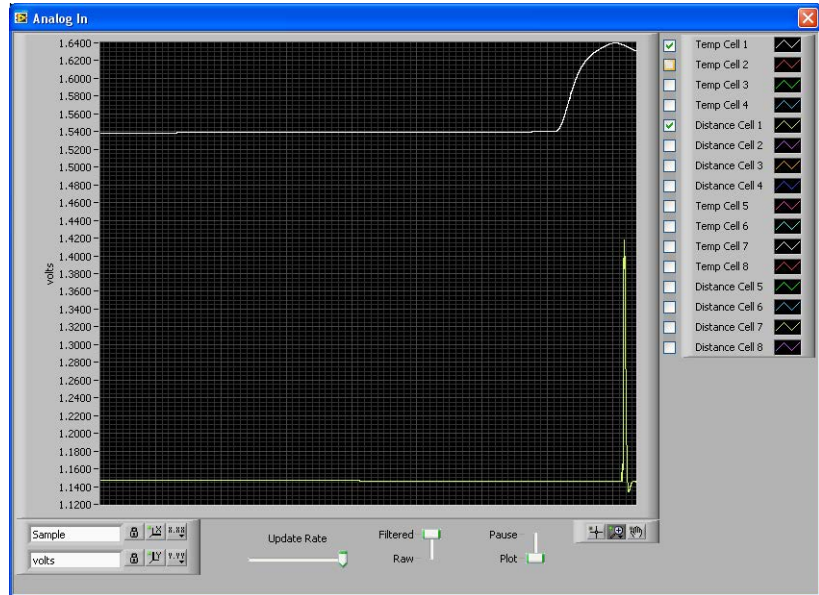

This screen shows the raw input received from the Swell Meter unit. Any change in either the thermocouple or the transducer should be immediately reflected on the graph.

To test the thermocouple, hold it in your hand for a few seconds. The temperature line on the graph should go up to reflect the increase in temperature.

To test the transducer, move it up and down and observe the graph. The distance line should move accordingly.

If the graph does not react as expected, the communication between the Swell Meter unit and the PC is not working properly. Check all cable connections and try again. If this does not correct the problem, contact OFITE for support.

Update Rate: Move this slider to the right to increase the update rate on the graph. Move it to the left to decrease the update rate.

Filtered/Raw: Position the slider on “Filtered” to filter out signal noise. Select “Raw” to see the raw signal without any filtering. The “Raw” setting is useful for troubleshooting.

Pause/Plot: Select “Pause” to pause the graph and temporarily stop plotting data. Move the slider back to “Plot” to restart the graph.

Operation

1. Turn on the Swell Meter. The switch for the first four channels is located on the left (from front) back of the unit. The switch for channels 5 through 8 is located on the rear right (from front) side of the console.
2. Start the Swell Meter software as described on page 6.
3. Zero all of the channels you intend to test. See page 8 for instructions.
4. Start the test on each channel. See page 10 for instructions.
5. Immediately insert the testing fluid into the cup through the hole in the cap. A 50 mL syringe, filled three times, is ideal for this application.
6. Insert the thermocouple through the hole in the cap.
7. Turn on the heated magnetic stirrer. To heat the fluid sample, turn the left knob until the displays shows the desired set point. Then press the knob in to set it. Repeat this process with the right knob to set the rotational speed.



The maximum temperature of the hot plate is 212°F (100°C), which is the boiling point of water. Testing at the boiling point could result in the fluid boiling out of the cup and splattering people and equipment. We recommend a maximum test temperature of 200°F (93.3°C).



The hot plate has a digital readout. Temperature measurement should be taken from the software only. Do not use the hot plate reading for temperature. Turn the hot plate dial slowly to adjust the temperature in the software.

8. Stop each channel when the test on that channel is complete. See page 10 for instructions.
9. When all tests are complete, turn off the power to the Swell Meter. Press both knobs on the stirrers to turn off the heat and the stirrer.
10. Disassemble the cup assembly and remove the sample from inside the transfer stand. Note the condition of the wafer (appearance and consistency).
11. Thoroughly wash and clean all components of the cup assembly.

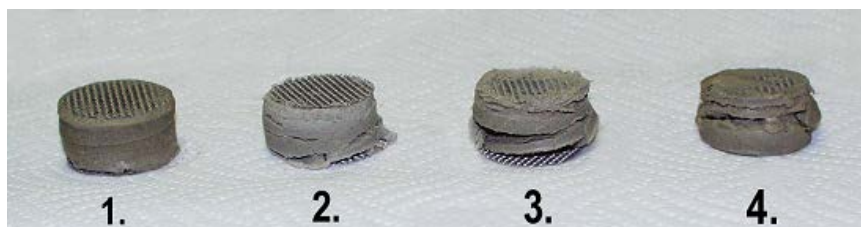

Sample Data

The following data was collected by running four separate tests on the following oilfield base fluids:

Fresh Water
Fresh Water + Glycol
Fresh Water + Potassium Acetate
Fresh Water + Glucose + Surfactant

Each individual test was run for 18 hours.

The wafers were prepared from materials of 100% Na-Montmorillonite (Bentonite), gumbo shale, and mixtures of bentonite/shales/sands. Also used was clay of medium to low reactivity similar to the material commonly referred to as "Rev Dust." The wafers were compressed at 6,000 PSI for 30 minutes.

The results and interpretation of the graphs using micro and macro temporal criteria clearly explain the following phenomena:

1. Reactivity of the fluid and resulting consequences on the wellbore stability
2. The differential speed it takes the additives to reach the surface of the mineral material
3. The probable distribution of the additives on the surface of the mineral material related to its molecular shape and molecular weight
4. Steric impediment phenomenon (space behavior)
5. Synergetic phenomenon
6. Depletion of the additive concentration over time
7. The mineral composition and physical characteristics (porosity, permeability) of the mineral matrix vs. the percent of expansion.

Sample Data

Graph 1

Graph No. 1 displays the bentonite - fluid interaction for the fluid during the entire 18.3 hours period for the test and very precisely shows the trend between the four fluids.

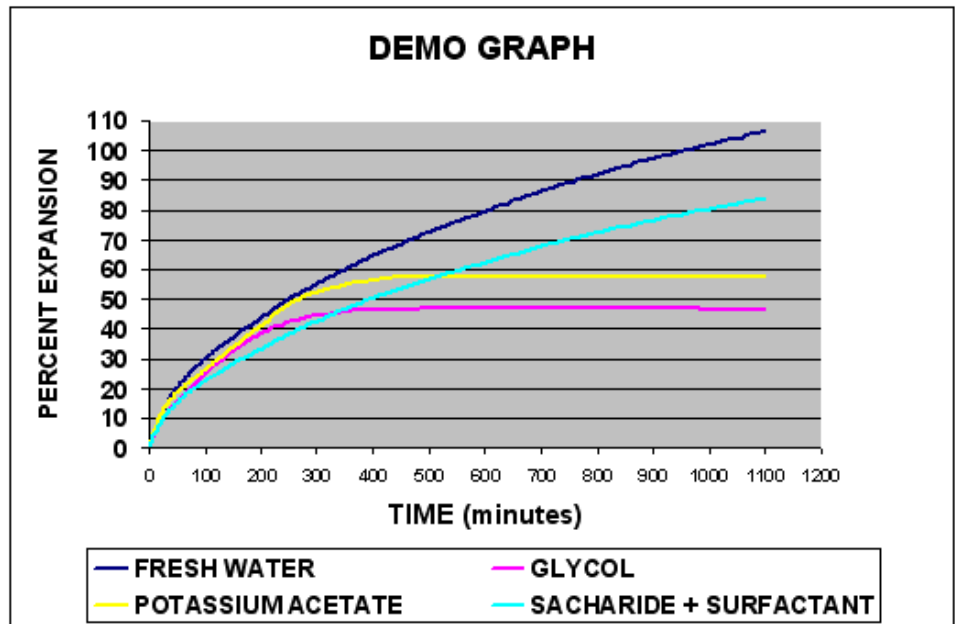

All of the base fluids show a positive slope which confirms an immediate and constant interaction between the clay and the base fluid.

The black curve of fresh water had the highest expansion rate - more than doubling its axial dimension.

The red curve of glycol showed the highest rate of shale stabilization over most of the test period. As seen in this graph, stabilization began around 275 minutes into the test with a maximum expansion of 46%. The glycol acted as the better shale stabilizer exceeding all other fluids. The amount of expansion stayed in a straight line of zero slope indicating a very positive balanced activity resulting in an ideal condition for wellbore stability.

The yellow curve of Potassium Acetate stabilized around 350 minutes into the test with a 58% expansion. This fluid also exhibits some shale stability although not quite as good as the glycol-based fluid.

The black curve of fresh water and the blue curve of the glucose + surfactant fluids showed very clearly that these fluids do not contribute to the stability of this shale sample.

The blue glucose + surfactant base initially acted as an adequate shale inhibitor, however after 330 minutes it was surpassed by the Glycol and after 500 minutes by the Potassium Acetate base fluid. While performing better than fresh water, its positive slope throughout the test showed a limited capacity as an effective shale stabilizer.

Sample Data

Graph 2

Graph No. 2 shows results obtained over an 8 hour time period and shows in greater detail the changes that occurred between the base fluids prior to and during stabilization of the glycol and potassium acetate fluids.

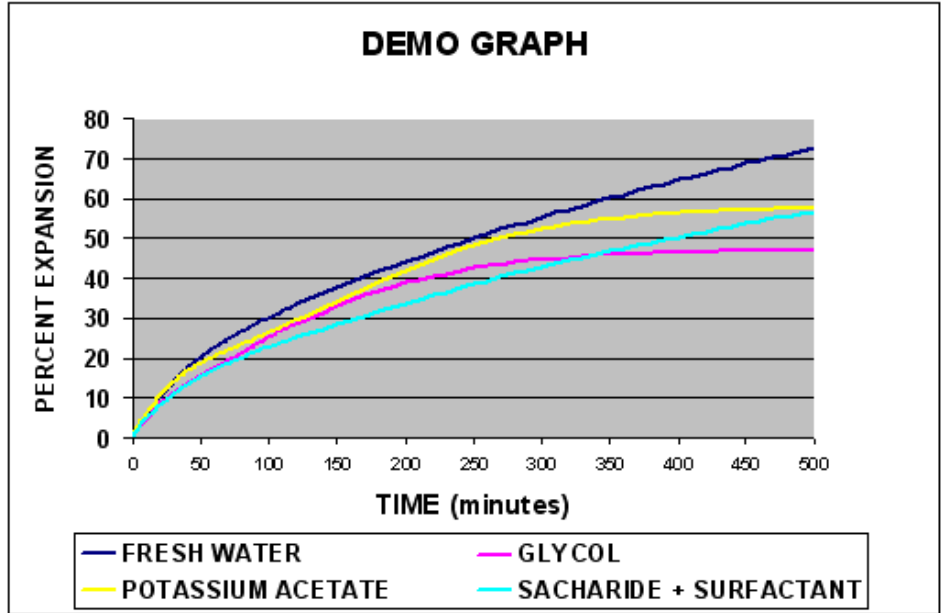

Sample Data

Graph 3

Graph No. 3 shows interesting micro views of the behavior of the different fluids up to 30 minutes into the test.

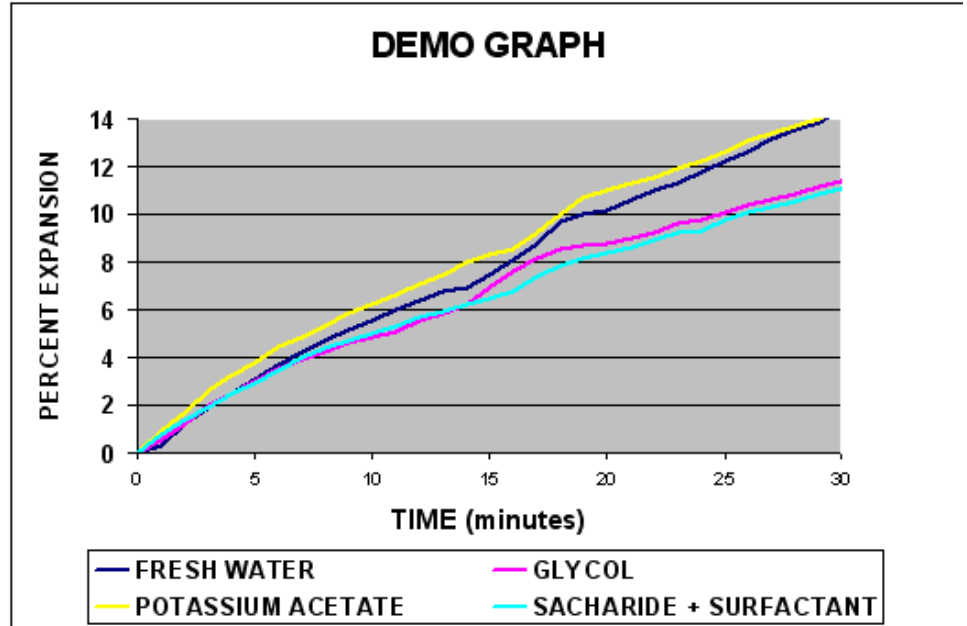

All fluids show a positive slope confirming an immediate interaction between the clay and the fluid bases.

The potassium acetate fluid initially showed the highest rate of expansion of the shale and this state continued up to around 28 minutes where the potassium acetate began acting as a better shale stabilizer base than the fresh water.

During the 15 to 20 minute time period ALL of the samples exhibited increased hydration as exhibited by the sudden increase in the slope of all of the curves.

Sample Data

Graph 4

Graph No. 4 shows a micro vision of the initial 5 minutes of the test.

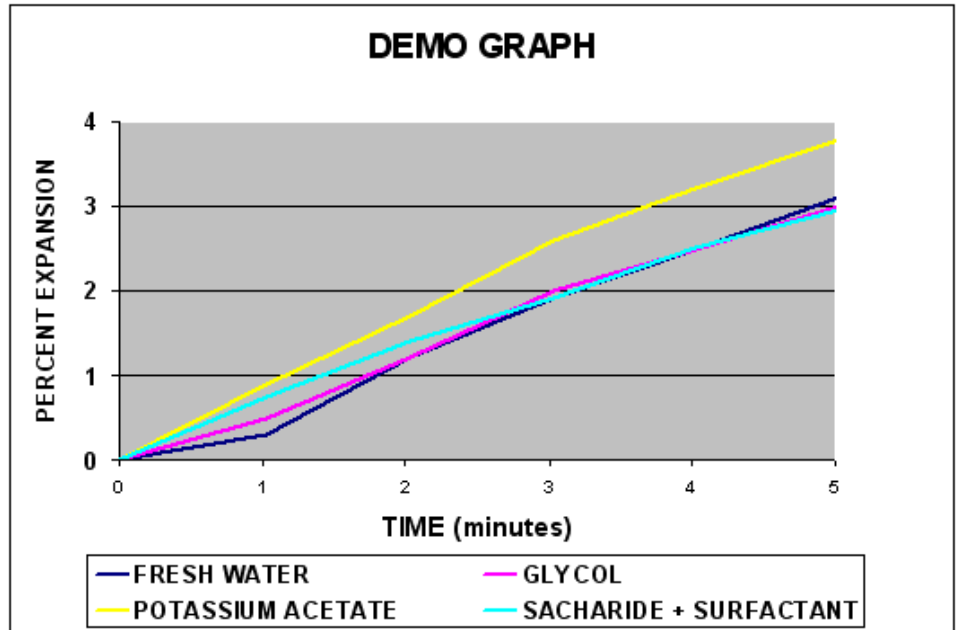

All four fluids still show a positive slope which again confirms an immediate interaction between the clay and the fluid. The fresh water initially showed the least amount of hydration of the four bases.

The yellow curve of potassium acetate had the highest rate of expansion at the beginning of the test. After 3 minutes with a 2.5% expansion, the slope decreased slightly.

After approximately 3 minutes, the fresh water, glycol and the glucose bases performed equally well, but they began to diverge in a short amount of time at the 5 minute mark.

Compactor

Assembly

The Compactor prepares the sample in wafer form so the expansion may be measured. As this is an enclosed vessel capable of very high pressures, extreme care should always be taken by the operator and anybody that is nearby. The Compactor can make two wafers at a time. Since the Compactor does not require electricity, it may be placed anywhere in the laboratory where shale or formation material is processed.

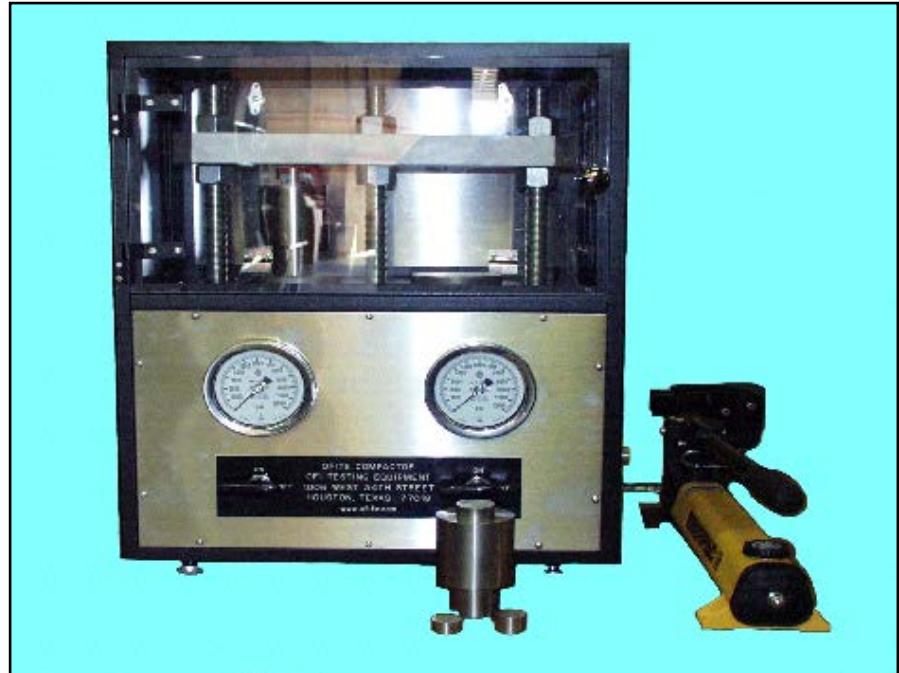

The cell assembly consists of the items listed below:

- Wafer Mold Body*
- Plunger*
- Drop Tube*
- Spacer, short, 14 mm*
- Spacer, tall, 20 mm*

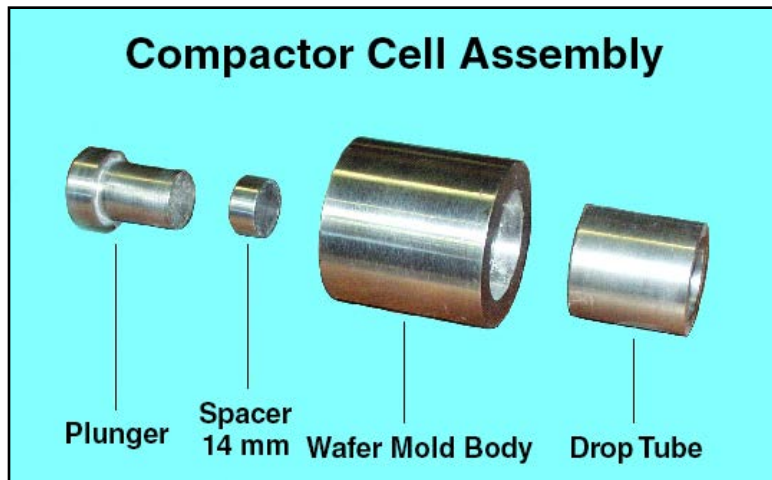



Note

1. Place the Drop Tube in the large open end of the Wafer Mold Body with the solid end of the Drop Tube facing the Wafer Mold Body.
2. Invert the assembly and pour the sample to be tested into the small opening of the Wafer Mold Body. The amount should not be less than 10 grams and not more than 20 grams.
3. Insert the thin, 14 mm Spacer in the Wafer Mold Body so that it rests on top of the sample.
4. Place the Plunger so the small end rests on top of the Spacer and the large expanded end is approximately 6-10 mm above the top of the Wafer Mold Body. The cell assembly is now ready.

Compactor

Making Wafers

1. Connect the hydraulic hand pump to the Compactor body via the quick connect.
2. Place the assembled cells (one or both assemblies) on the individual pedestals with the piston side of the cell assembly in the up position.
3. Close the plexiglass door.
4. Pressure may be applied to only one cell assembly at a time. Turn one of the knobs on the front of the compactor to the "ON" position.
5. Close the valve on the hand pump by turning it in a clockwise motion until it will turn no more.
6. Pumping the hand pump handle will apply pressure to the Compactor. The pedestal base and the cell assembly will begin rising in the Compactor. Observe the pressure gauge on the front of the Compactor and continue pumping until the desired pressure is reached.
7. Once the desired pressure is reached, turn the knob on the front of the Compactor to the "OFF" position. Maintain this pressure for as long as desired. A typical compaction run is 6000 PSI for a 30 minute period, but this may vary with different operators and test materials.
8. After the first cell assembly has been properly pressurized, the second cell assembly may be started by opening the valve on the front and proceeding with steps 4 through 7 above. The pressure on this second cell does not have to be the same as that of the first cell assembly.

Compactor

Disassembly

1. Open the valve on the hand pump by turning it counterclockwise as far as possible until it stops.
2. Turn one or both valves on the front of the Compactor to the "ON" position. This will release the pressure on the cell assemblies. The pedestals and cell assemblies should lower in position and the gauges on front of the Compactor should return to zero.
3. Remove the cell assemblies from the Compactor.
4. Re-position the valves on the front of the Compactor to the "OFF" position.
5. Remove the receiver from the cell assembly and invert it, replacing and repositioning it so that the open side of the receiver faces the cell body.
6. Remove the piston and the spacer from the opposite end of the cell body.
7. Drop the tall 20 mm spacer and position it in place where the thin spacer had been. Re-position the piston as before.
8. Replace the cell assembly inside the Compactor with the piston on the upper side.
9. Apply pressure to the cell assembly by turning the valve in front to the "ON" position and by turning the valve on the hand pump clockwise. Apply pressure with the hand pump and observe the gauge. The needle will initially rise, but the gauge will then suddenly drop to a reading of zero. This happens when the wafer breaks free from the cell assembly and falls into the receiver. The preparation for this wafer is now complete.
10. Pressure may now be applied to the other cell assembly for removal of the wafer.



Note

The wafer should go directly to a desiccator in order to prevent moisture absorption. Moisture will result in swelling and will give erroneous results, especially when doing comparative analysis studies.

Drawings

Cup Assembly

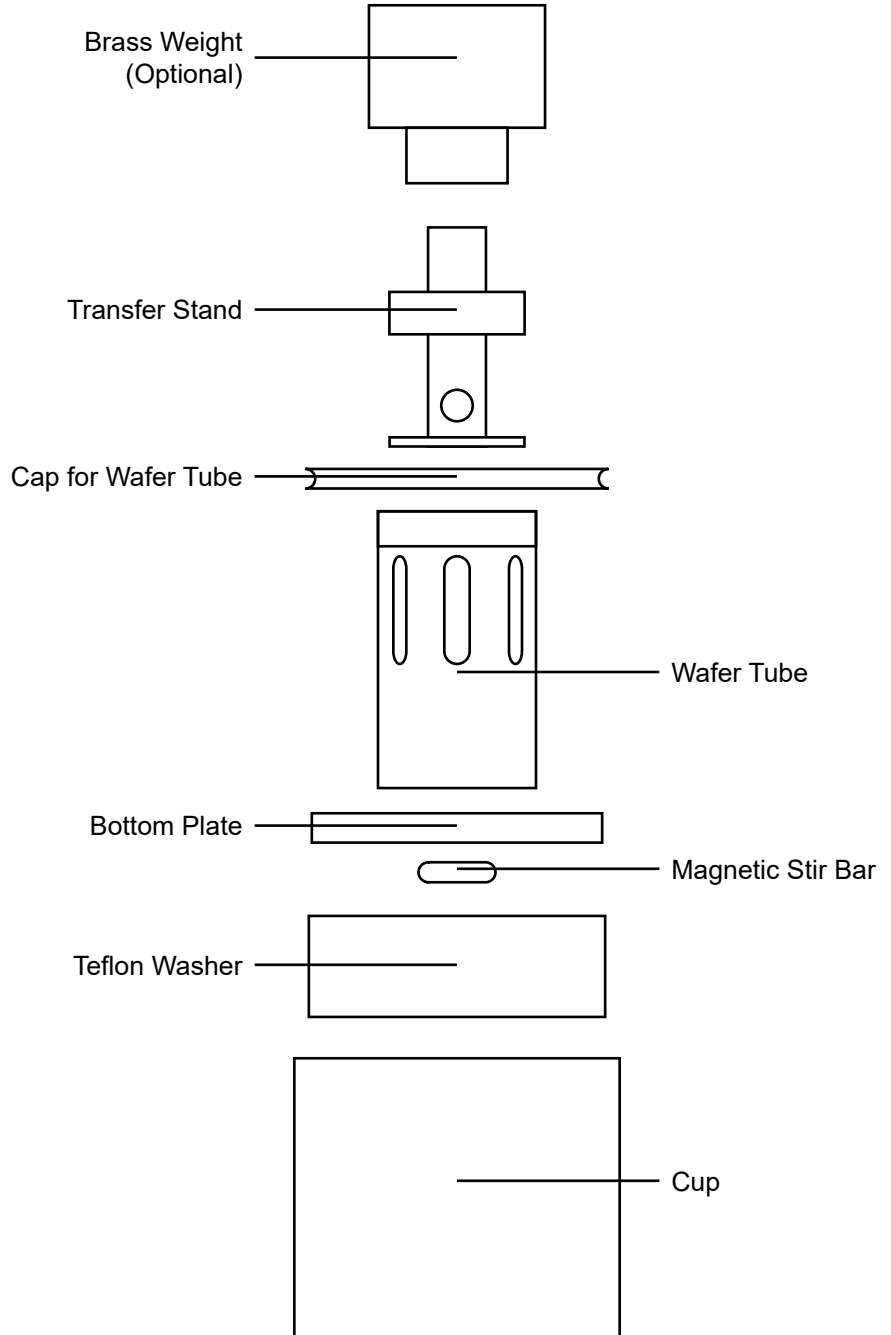

Drawings

Head Assembly

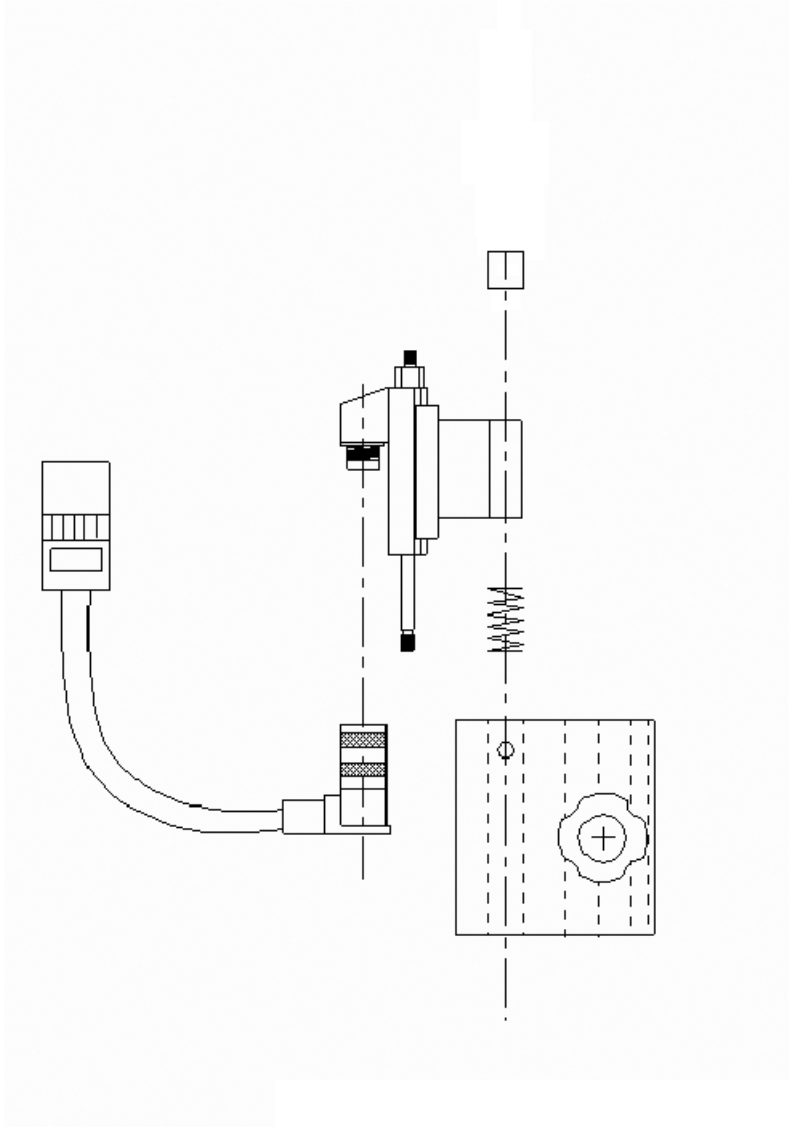

Drawings

Main Assembly

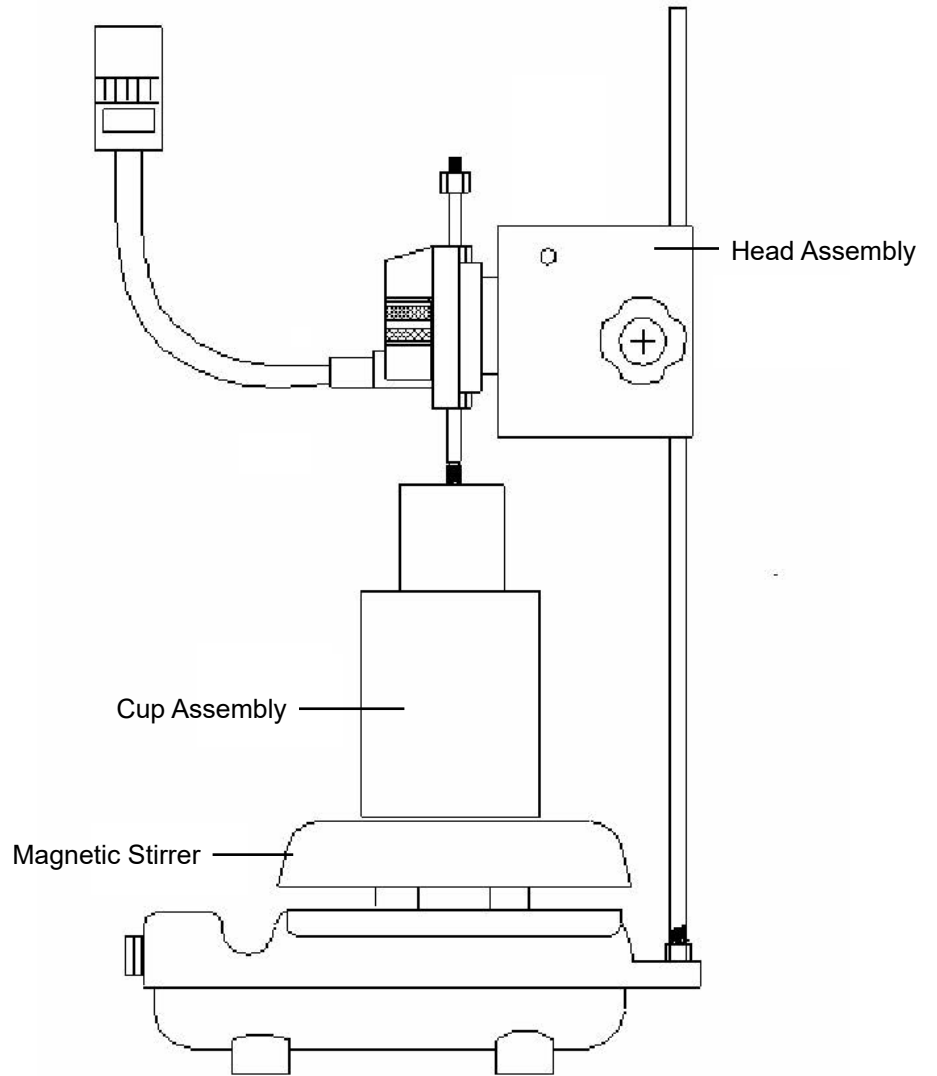

Drawings

Wafer Die

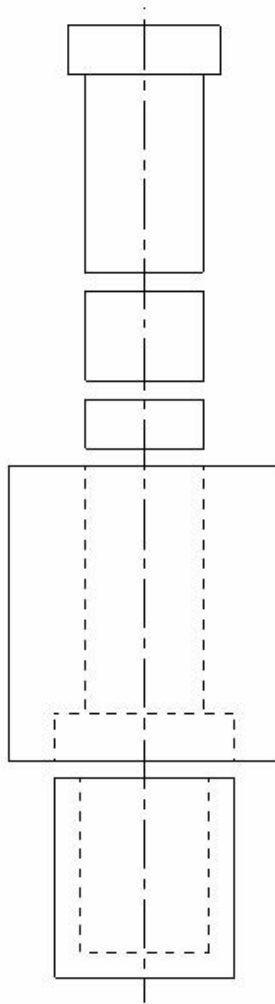

Specimen Removal

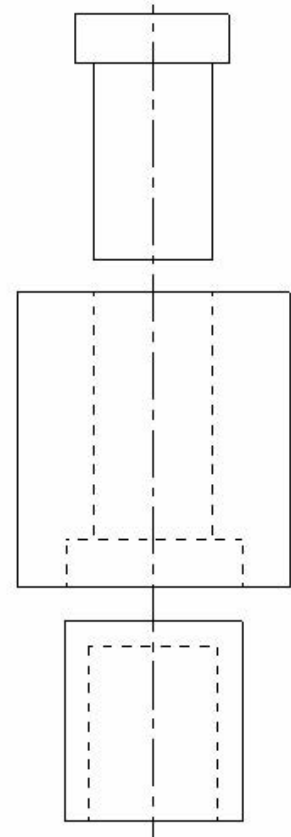

Specimen Creation

Warranty and Return Policy

Warranty:

OFI Testing Equipment, Inc. (OFITE) warrants that the products shall be free from liens and defects in title, and shall conform in all respects to the terms of the sales order and the specifications applicable to the products. All products shall be furnished subject to OFITE's standard manufacturing variations and practices. Unless the warranty period is otherwise extended in writing, the following warranty shall apply: if, at any time prior to twelve (12) months from the date of invoice, the products, or any part thereof, do not conform to these warranties or to the specifications applicable thereto, and OFITE is so notified in writing upon discovery, OFITE shall promptly repair or replace the defective products. Notwithstanding the foregoing, OFITE's warranty obligations shall not extend to any use by the buyer of the products in conditions more severe than OFITE's recommendations, nor to any defects which were visually observable by the buyer but which are not promptly brought to OFITE's attention.

In the event that the buyer has purchased installation and commissioning services on applicable products, the above warranty shall extend for an additional period of twelve (12) months from the date of the original warranty expiration for such products.

In the event that OFITE is requested to provide customized research and development for the buyer, OFITE shall use its best efforts but makes no guarantees to the buyer that any products will be provided.

OFITE makes no other warranties or guarantees to the buyer, either express or implied, and the warranties provided in this clause shall be exclusive of any other warranties including ANY IMPLIED OR STATUTORY WARRANTIES OF FITNESS FOR PURPOSE, MERCHANTABILITY, AND OTHER STATUTORY REMEDIES WHICH ARE WAIVED.

This limited warranty does not cover any losses or damages that occur as a result of:

- Improper installation or maintenance of the products
- Misuse
- Neglect
- Adjustment by non-authorized sources
- Improper environment
- Excessive or inadequate heating or air conditioning or electrical power failures, surges, or other irregularities
- Equipment, products, or material not manufactured by OFITE
- Firmware or hardware that have been modified or altered by a third party
- Consumable parts (bearings, accessories, etc.)

Returns and Repairs:

Items being returned must be carefully packaged to prevent damage in shipment and insured against possible damage or loss. OFITE will not be responsible for equipment damaged due to insufficient packaging.

Any non-defective items returned to OFITE within ninety (90) days of invoice are subject to a 15% restocking fee. Items returned must be received by OFITE in original condition for it to be accepted. Reagents and special order items will not be accepted for return or refund.

OFITE employs experienced personnel to service and repair equipment manufactured by us, as well as other companies. To help expedite the repair process, please include a repair form with all equipment sent to OFITE for repair. Be sure to include your name, company name, phone number, email address, detailed description of work to be done, purchase order number, and a shipping address for returning the equipment. All repairs performed as "repair as needed" are subject to the ninety (90) day limited warranty. All "Certified Repairs" are subject to the twelve (12) month limited warranty.

Returns and potential warranty repairs require a Return Material Authorization (RMA) number. An RMA form is available from your sales or service representative.

Please ship all equipment (with the RMA number for returns or warranty repairs) to the following address:

OFI Testing Equipment, Inc.
Attn: Repair Department
11302 Steeplecrest Dr.
Houston, TX 77065
USA

OFITE also offers competitive service contracts for repairing and/or maintaining your lab equipment, including equipment from other manufacturers. For more information about our technical support and repair services, please contact techservice@ofite.com.